

MABEF

Ed. 2017

M.A.B.E.F. srl

Via A. Volta, 77 /79
21010 Cardano al Campo
(Varese) - Italy
Tel. +39.0331.261.651

www.mabef.it
E-mail:support@mabef.it

Registra il tuo prodotto per estendere la garanzia a vita.

Register your product to extend the lifetime warranty



© MABEF 2017

È vietata la riproduzione o l'adattamento anche parziale - con qualsiasi mezzo comprese le copie fotostatiche - la memorizzazione elettronica, l'utilizzo delle immagini di questo stampato senza esplicita autorizzazione.

No part of this publication may be reproduced or used in any form or by any means - graphic, electronic, or mechanical including photocopying - without prior permission.



MABEF

M/09

CAVALLETTO DA STUDIO
STUDIO EASEL

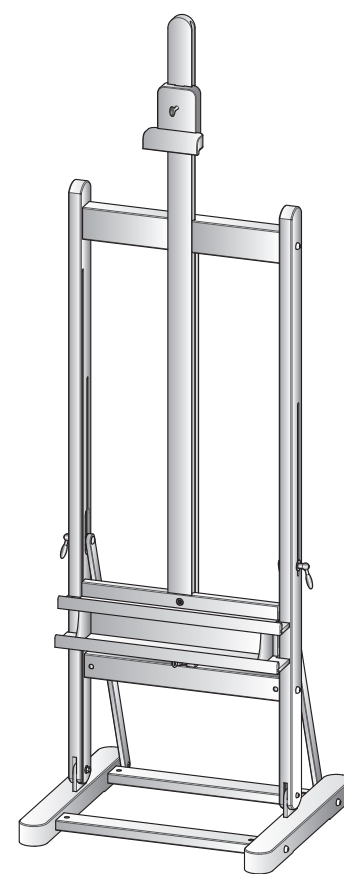

Istruzioni video
Video instructions



1 1x Asta a cremagliera
Ratchet post

2 1x Traversa superiore
Upper crossbar

3 1x Traversa inferiore
Lower crossbar

4 1x Asta laterale sinistra
Left side post

5 x1 Asta laterale destra
Right side post

6 x2 Traversa base
Pedestal crossbar

7 x1 Piedestallo sinistro
Left pedestal leg

8 x1 Piedestallo destro
Right pedestal leg

9 x1 Cassetta porta tela
Canvas/brush tray

10 x1 Asta centrale
Central post

11 x1 Blocco ferma quadro
Top canvas holder

A x1 mm. 4

B x4 mm. 6x95

C x8 mm. 10x20x6

D x4 mm. 6x50

E x2 mm. 6x35

F x2 mm. 6x12

G x2 mm. 6

H x1 mm. 14x20x8
mm. 8x8

I x2 mm. 6x60

L x4 mm. 6x24

M x2 mm. 6x60

N x1 mm. 6x30

O x1 mm. 5x30

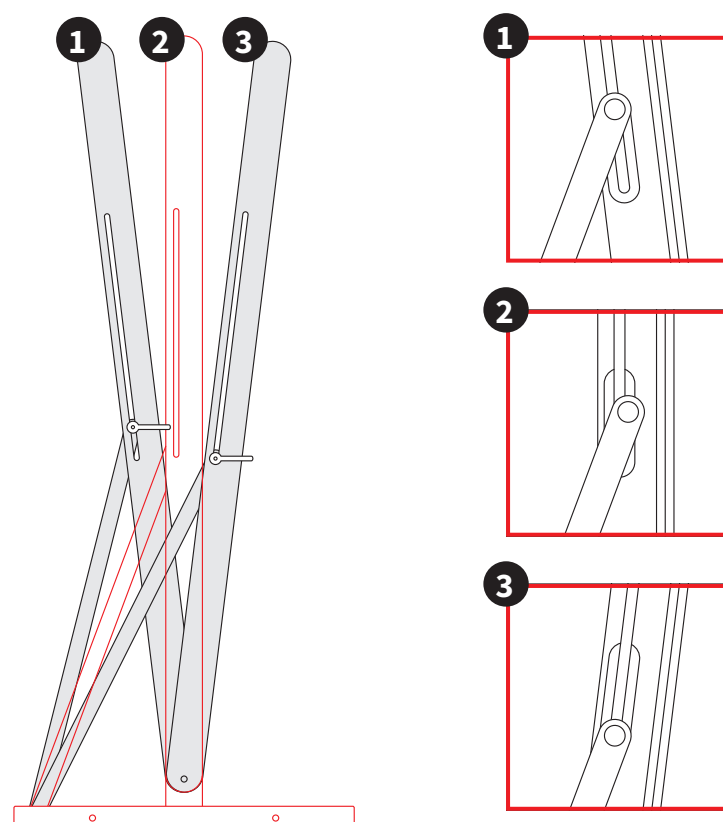
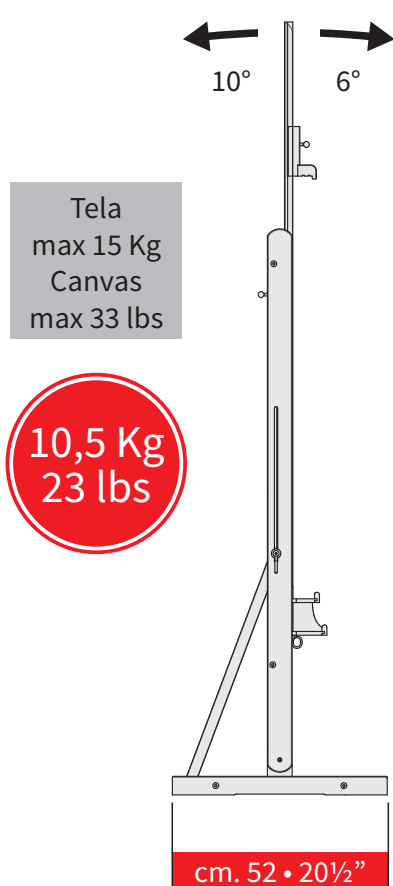
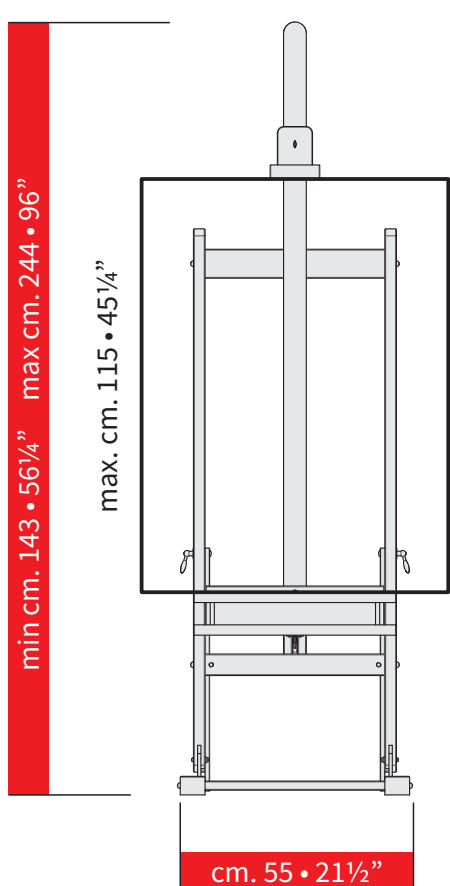
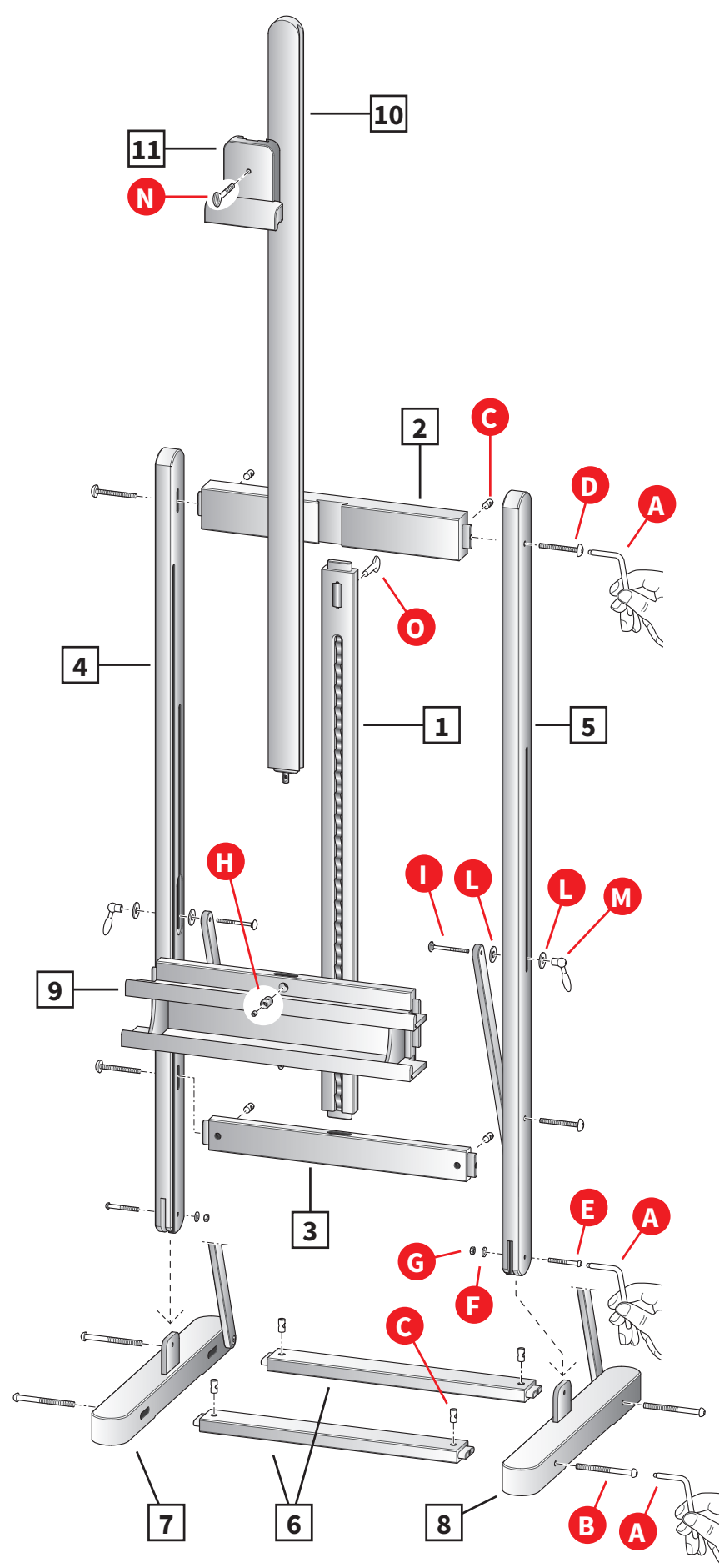

Sistema antiribaltamento - Non-collapsible system

